

UNITRAFO

Cast Resin Transformers Ecodesign Tier 2 Voltage Class 12 kV

Standards	IEC 60076 - EN 50588 - EU 548/2014
Insulating Class (Temperature Rise)	F (100 K)
Insulation Class MV	12 kV FI 28 kV BIL 75 kV
Insulation Class LV	1,1 kV FI 3 kV
Frequency	50 Hz
Tappings MV	± 2 x 2,5%
Tolerance	No tolerance on the losses

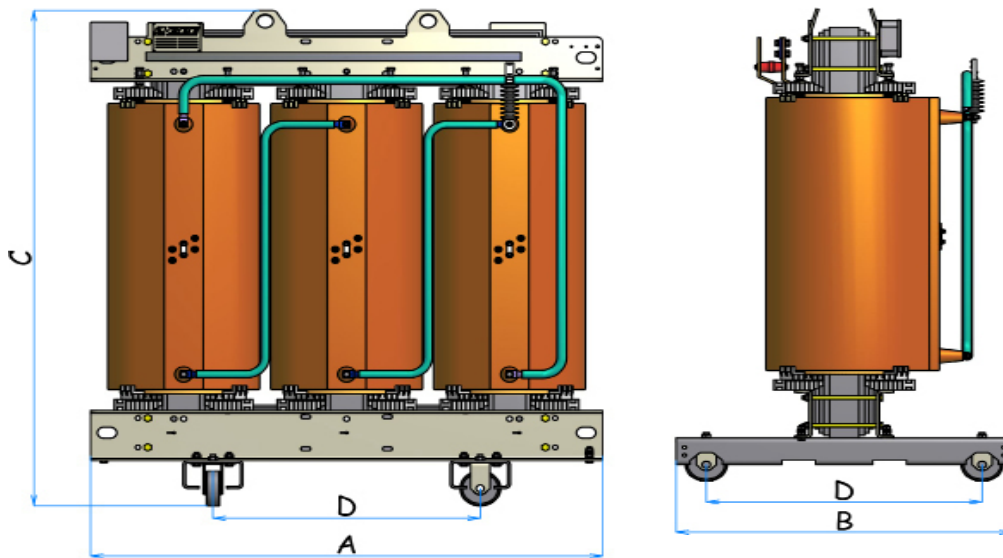

Power kVA	Uk * %	P _o W	Pcc * W	I _o %	LwA dB(A)	LpA dB(A)	A mm	B mm	C mm	D mm	Wheel mm	Weight Kg
100	6	250	1800	0,65	50	38	1250	670	1095	520	125	840
160	6	360	2600	0,62	53	40	1250	670	1175	520	125	980
200	6	400	2950	0,60	55	42	1250	670	1285	520	125	1120
250	6	460	3400	0,58	56	43	1250	670	1365	520	125	1340
315	6	550	3870	0,57	58	45	1260	820	1460	670	125	1490
400	6	670	4500	0,54	59	46	1330	820	1510	670	125	1760
500	6	810	5630	0,50	60	47	1360	820	1550	670	125	1880
630	6	990	7100	0,46	61	47	1360	820	1550	670	125	2010
800	6	1170	8000	0,43	63	49	1570	820	1680	670	125	2450
1000	6	1390	9000	0,38	64	50	1570	1000	1880	820	125	2920
1250	6	1620	11000	0,36	66	52	1680	1050	1990	820	160	3420
1600	6	1980	13000	0,32	67	52	1680	1050	2140	820	160	4150
2000	6	2340	16000	0,31	69	54	2010	1300	2280	1070	200	5190
2500	6	2790	19000	0,29	70	55	2010	1300	2380	1070	200	5840
3150	7	3420	22000	0,27	73	58	2100	1300	2415	1070	200	7230

* Data referred to 120°C at rated voltage
Po = Non load losses | Pk = Load losses | Ptot (Po+Pk) = Total losses

N.B. Dimensions and weights are preliminary and will be confirmed upon order

Standard equipment

- Terminal board for voltage regulation of $\pm 2 \times 2,5\%$ (Disconnected transformer)
- High Voltage output insulator
- HV connections with n.3 brass details M12
- LV connections plate in aluminum
- Earthing link
- Thermometer with 2 changeover contacts, type JUMO
- Lugs/eyebolts for lifting or horizontal movement
- Trucks (2 pcs) with orthogonal swivelling revolving wheels (4 pcs)
- Ratingplates in accordance with IEC 60076 (2 pcs, whereof one is delivered unmounted)
- Standard testing, including relevant test certificate
- Documentation as digital files

CAST RESIN TRANSFORMER – PRINCIPLE SKETCH

- 1 Earthing Terminal
- 2 Medium Voltage Output Insulator
- 3 Medium Voltage Tapping
- 4 Medium Voltage Windings
- 5 Low Voltage Windings
- 6 Windings Pressure Plugs
- 7 Low Voltage Output Bars
- 8 Magnetic Core
- 9 Lifting Eyebolts
- 10 Centralization Auxiliary Box
- 11 Data Plate
- 12 Thermal Sensors
- 13 Core Frame
- 14 Eyebolts for Horizontal Movement
- 15 Orthogonal Revolving Wheels

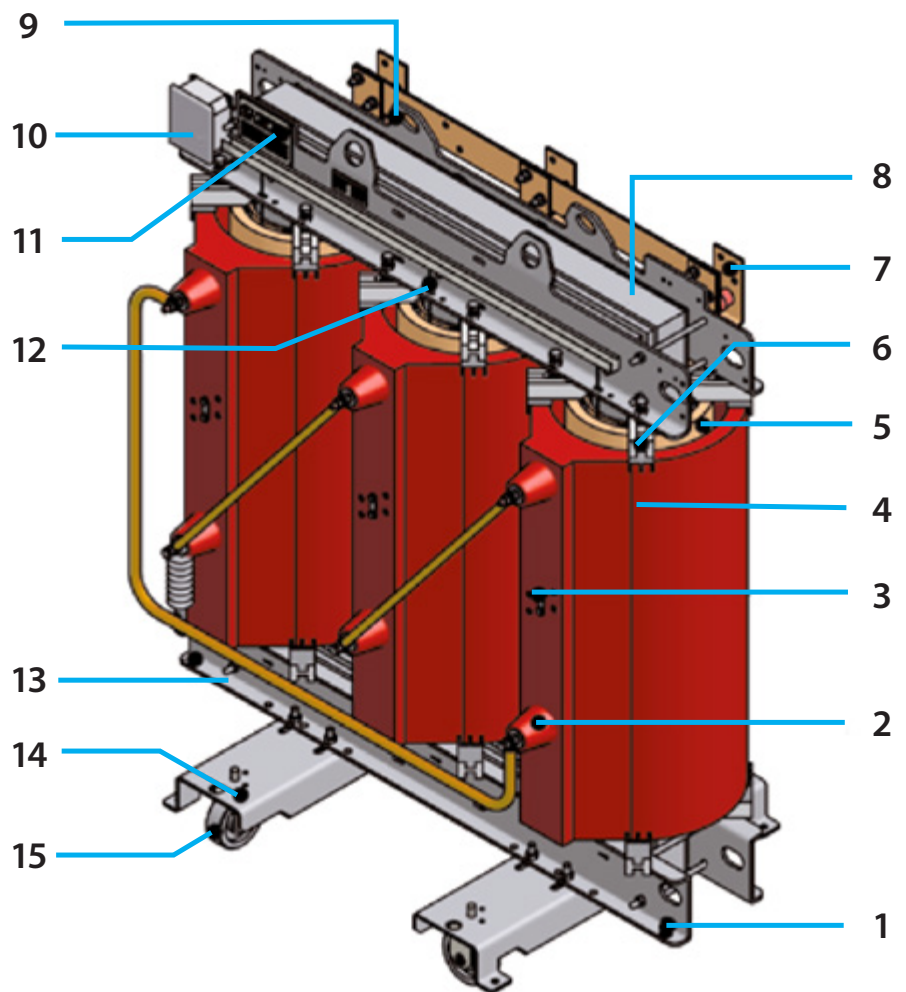

Options

As an alternative option we can adapt our transformers for your specific needs. For instance we can offer you transformers with extra low losses, windings in copper for special applications, alternative temperature risings and calsses,

double primary- or secondary current, alternative frequencies, low fitted bushings and vector groups as desired. Below you can see some of the options we offer.

TEMPERATURE SUPERVISION

ITEM NO.	DESCRIPTION	ITEM NO.	DESCRIPTION
2	Digitalt thermo instrument with 3 contacts for PT100, T154 Tecsystem	7	PT-100-sensor, 3 pcs incl. mounting
3	Temperature relay for PTC-termistors, T119 Tecsystem	10	Thermometer with 2 changeover contacts, type JUMO
4	Digitalt thermo instrument for PT100 with analogue output 4-20 mA or serial 485-connection or modbus, NT935 Tecsystem	10-P	Temperature transmitter incl. program display, with analouge output 4-20 mA for PT100-sensor

ADDITIONAL ACCESSORIES

ITEM NO.	DESCRIPTION	ITEM NO.	DESCRIPTION
33	Complete fan cooling for forced cooling (power increase +30%) including digitalt temperature instrument T154 and protective relay for fan engines VRT200 (pos 2+36.2). Up to 3150 kVA	42	Electrostatic screen between primary and secondary voltage, max 1,1 kV
36.2	Protective relay for fan engine VRT200 for panel mounting. (N.B. included in the package above)	43	Housing protection - plexiglass
38	Antivibration pads, set of 4 pcs/ transformer	43.1	Plexiglass protection for terminal boards
40	Earthing bolts for HV- or LV-side (Ø 25 mm)	44	Cupal plates
40 A	Earthing link, type Pfisterer (earthing link, control rod och hanger) for work earthing at HV-side with max allowed short circuit current for one second	58	Low placed secondary voltage connectors
40 B	Earthing switch, type ABB, EB12/24, HV-side. Complete with help contact, locking solenoid, hand lever and front		

TESTING*

ITEM NO.	DESCRIPTION	ITEM NO.	DESCRIPTION
	Shock test (up to 6300 kVA)		Heat test
	Sound test		Participation in test at the factory

* Standard testing according to IEC 60076, is always included.